



Dual Port SMD 10/100Base-T Isolation Transformer Modules

Features

- Low profile and light weight 10/100 BaseT modules facilitate pick and place compatibility and speed of placement
- Meets requirements of IEEE 802.3u and ANSI X3.263
- Consistent and reliable coplanarity
- Excellent quality at extremely competitive price due to high volume production
- Manufactured in an ISO-9001:2000, TS-16949:2002 and ISO-14001:2004 certified Talema facility
- Fully RoHS compliant and meets lead free reflow level J-STD-020C

Electrical Specifications @ 25°C

Inductance: 350µH minimum @ 100kHz, 100mV, 8mA

Leakage Inductance: 0.4µH @ 1MHz

C_{www}: 20pF typical

Minimum isolation voltage: 1500 Vrms

Operating Temperature Range: -40°C to +85°C

Storage Temperature: -40°C to +125°C

Standard Packing: Tape and Reel

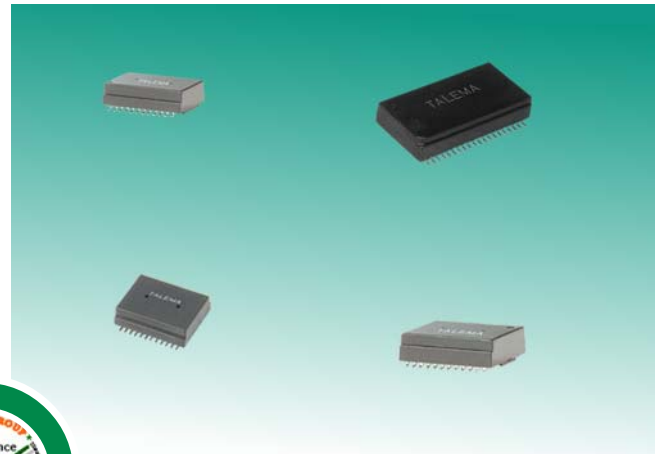

Quality and consistency is guaranteed through 100% testing of the specified parameters for primary inductance, leakage inductance, turns ratio, DC resistance and interwinding capacitance. This ensures that the return loss and pulse wave shape requirements can be fully maintained. Additionally, all parts are tested for 1500V minimum isolation.

Applications

Talema 10/100BaseT Dual transformer modules contain transmit and receive isolation transformers to maintain consistent wave shape and suppression of common mode noise while providing equipment isolation per IEEE 802.3. High impedance common mode quad chokes for additional EMI suppression have been added on some models as required for FCC and CISPR 22 Class B certification.

TED Series - SMD Dual Port 10/100Base-T Isolation Transformer Modules

Part Number	Turns Ratio ±2%		Insertion Loss (dB Typ)	Return Loss (dB Min)				Crosstalk (dB Typ)				Differential to Common Mode Rejection (dB Typ)		Schematic
	Tx	Rx		0.1 - 100 MHz	2-30 MHz	40 MHz	50 MHz	60-80 MHz	1 MHz	30 MHz	60 MHz	100 MHz	1-60 MHz	
TED-100A	1ct:1ct	1ct:1ct	-1.2	-18	-16	-14	-12	-50	-42	-40	-35	-39	-33	A
TED-104A	2ct:1ct	1ct:1ct	-1.2	-18	-16	-14	-12	-50	-42	-40	-35	-39	-33	A
TED-100B	1ct:1ct	1ct:1ct	-1.1	-18	-16	-14	-12	-35	-35	-35	-35			B
TED-200A-J	1ct:1ct	1ct:1ct	-1.2	-16	-14	-13	-12	-50	-45	-40	-35	-37	-33	A
TED-200B-J	1ct:1ct	1ct:1ct	-0.5	-21	-17	-14.5	-12	-65	-55	-45	-35	-45	-35	B
TED-200C-J	1ct:1ct	1ct:1ct	-0.5	-21	-17	-14.5	-12	-65	-55	-45	-35	-40	-30	C
TED-200E-J	1ct:1ct	1ct:1ct	-1.0	-16	-14.4	-13	-12	-50	-45	-40	-35	-37	-33	E
TED-200G-J	1ct:1ct	1ct:1ct	-0.5	-21	-17	-14.5	-12	-65	-55	-45	-35	-53	-40	G
TED-200H-J	1ct:1ct	1ct:1ct	-0.5	-21	-17	-14.5	-12	-65	-55	-45	-35	-45	-35	H
TED-300A	1ct:1ct	1ct:1ct	-1.1	-18	-16	-14	-12	-50	-42	-38	-33	-39	-33	A
TED-300B	1ct:1ct	1ct:1ct	-1.1	-18	-16	-14	-12	-50	-44	-39	-35	-37	-30	B
TED-300C	1ct:1ct	1ct:1ct	-1.2	-18	-16	-14	-12	-60	-45	-40	-35	-45	-35	C
TED-300D	1ct:1ct	1ct:1ct	-1.2	-18	-16	-14	-12	-60	-45	-40	-35	-45	-35	D
TED-400D	1ct:1ct	1ct:1ct	-1.2	-16	-14	-13.5	-10	-55	-45	-40	-35	-30	-30	D

Dimensions and Schematics on following pages

Dimensions & Schematics • SMD Dual Port 10/100Base-T Isolation Transformer Modules

Dimensions: Inches (Millimeters)
Tolerance: ± 0.010 (0.25) unless specified otherwise

Surface coplanarity will be 0.004 (0.01) maximum

TED-100

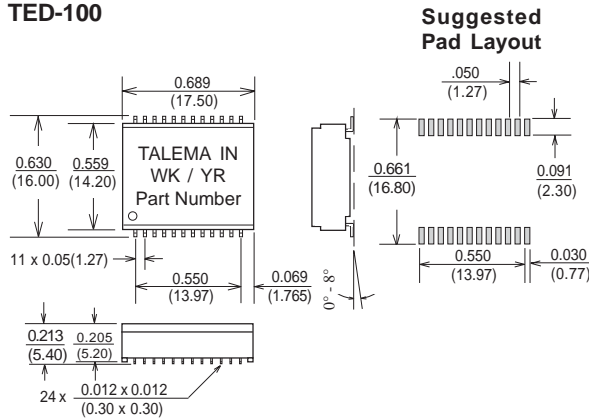

Schematic

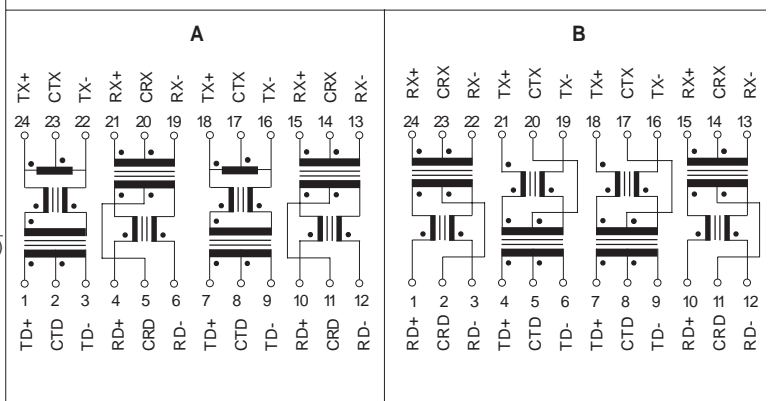

TED-200

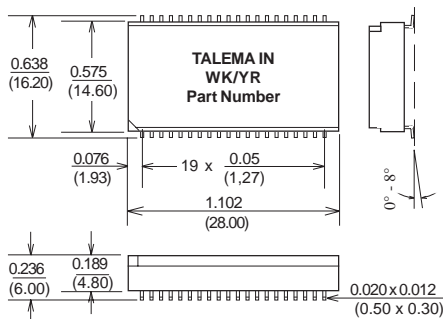

Schematic

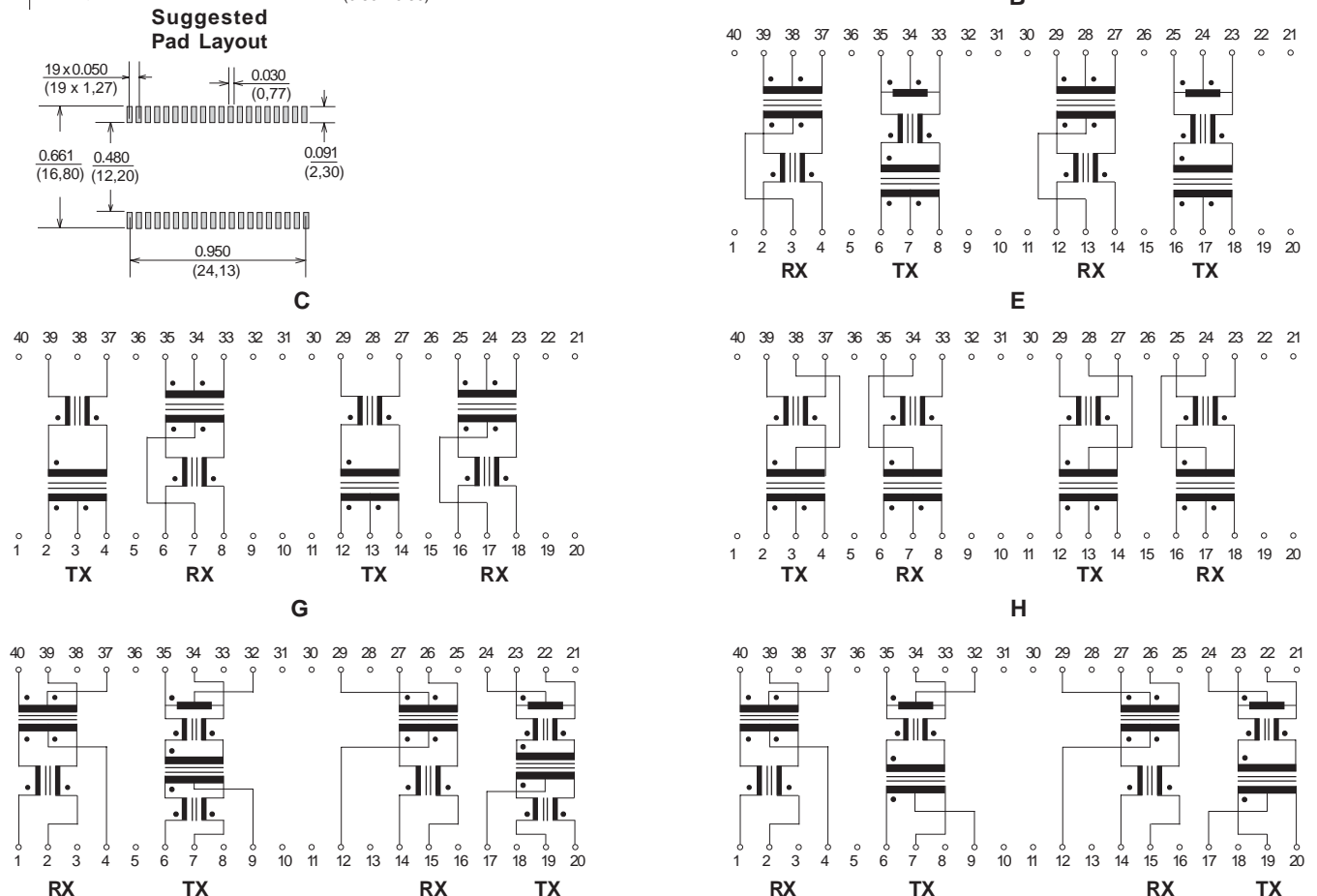

Dimensions & Schematics • SMD Dual Port 10/100Base-T Isolation Transformer Modules

TED-300

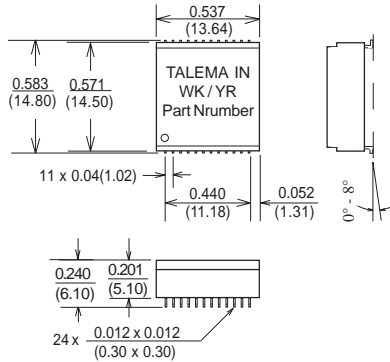

Suggested Pad Layout

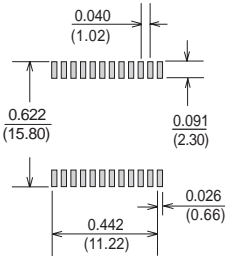

Schematics

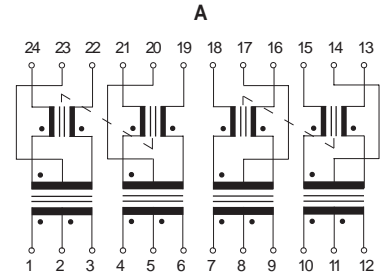

B

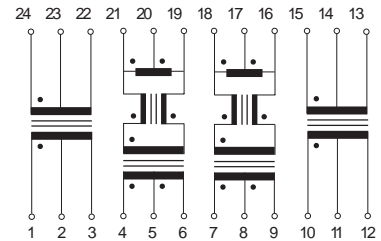

C

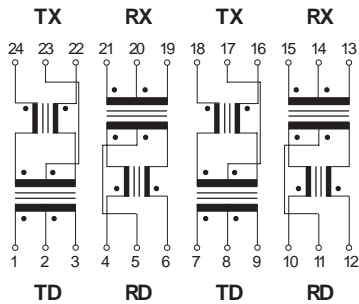

D

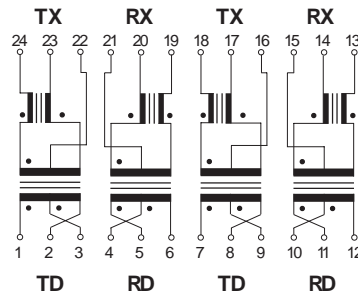

TED-400

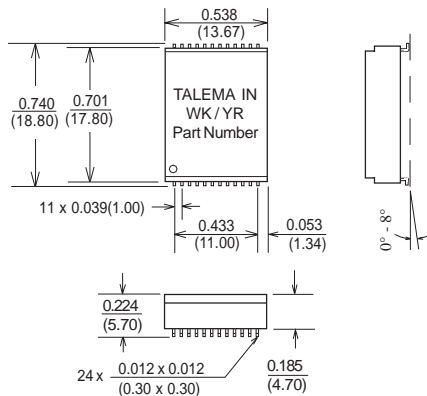

Suggested Pad Layout

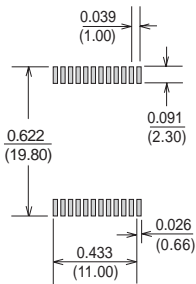

Schematic

D

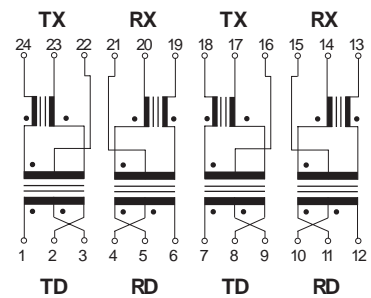

Sales & Marketing, Design and Manufacturing Facilities

<http://www.talema-nuvotem.com>

Eastern Europe & Czech Republic

NT MAGNETICS s.r.o.
Chebská 27
322 00 Plzeň
Tel: Int. + 420 37 - 744 9303
Fax: Int. + 420 37 - 744 3697
Email: talema@talema.cz

Germany

TALEMA ELEKTRONIK GMBH
Sembdnerstr. 5, Postfach 2523
82110 Germering
Tel: Int. + 49 89 - 841 00 - 0
Fax: Int. + 49 89 - 841 00 25
Email: info@talema.de

Ireland

NUVOTEM TEO.
Crolly
Co. Donegal
Tel: Int. + 353 74 - 954 8666
Fax: Int. + 353 74 - 954 8139
Email: info@nuvotem.com

India

TALEMA ELECTRONIC PVT. LTD.
Opposite the SIDCO Industrial Estate
Gins Towers
4/5S.H/1, Omalur Main Road
Salem - 636 004, Tamil Nadu
Tel: Int. + 91 427 - 244 1325
Fax: Int. + 91 427 - 243 0034
E-mail: talema@talemaindia.com